

# Electronic Pressure Switch with Display Model PSD-30

WIKA Data Sheet PE 81.67



## Applications

- Machine-building
- Machine tools
- Hydraulics / pneumatics
- Pumps and compressors

## Special features

- Easily-readable, robust 14-segment LED display; electronically 180° rotatable
- User-friendly 3-key operation
- Easy menu navigation (according VDMA Standard)
- Flexible installation with independent rotation between the M12 connection (320°) and the display (330°)
- Configuration with IO-Link interface (optional)

### Award-winning in Design and Functionality

The successful design and outstanding functionality have already been honoured with the award of the iF product design award 2009. The display, with its 9 mm high digits, was designed to be as large as possible and was made at a slight angle, so that the displayed pressure can be easily read from a distance. Proven and robust LED technology has been used, with a 14-segment display employed so that alphanumeric messages are well represented.

The buttons used to set the switch parameters have been maximised in their size and ergonomically arranged. Their tactile feedback supports, and thus enables, usage without additional assistance. The three keys ensure easy, intuitive menu navigation.

This menu navigation is in accordance with the new VDMA Standard. This VDMA Standard Form for fluid sensors (24574-1, Part 1, pressure switch) has the aim of simplifying the use of pressure switches by standardising the menu navigation and display.



## Pressure Switch PSD-30

### Flexible and adaptable

During commissioning the PSD-30 can be adapted, flexibly, to the mounting conditions. Due to the dual rotatability of the housing through more than 300°, the display can be adjusted independently of the electrical connection. The display, therefore, can always be aligned towards the operator while the M12 connection can always be aligned to suit the desired cable run. If the equipment is to be installed overhead, the display can also be turned electronically through 180°.

### High Quality

During development, great importance was attached to providing a robust design and an appropriate choice of materials. For this reason, both the housing and the threaded connector for the electrical plug are made from stainless steel. Overtightening or breaking the plug is thus almost impossible. Our own sensor technology, tested over many years, is used. Whether metal thin film or piezoresistive sensors, they are hermetically welded and implemented without additional internal seals.

# Specifications

## Model PSD-30

Pressure ranges	bar	1	1.6	2.5	4	6	10	16	25	
Over pressure safety	bar	2	3.2	5	8	12	20	32	50	
Burst pressure	bar	5	10	10	17	34	34	100	100	
Pressure ranges	bar	40	60	100	160	250	400	600		
Over pressure safety	bar	80	120	200	320	500	800	1200		
Burst pressure	bar	400	550	800	1000	1200	1700	2400		
MPa and kg/cm <sup>2</sup> are available										
{Absolute pressure: 0 ... 1 bar bis 0 ... 25 bar}										
{Vacuum pressure: -1 ... 0 bar bis -1 ... 24 bar}										
Pressure ranges	psi	15	25	30	50	100	160	200	300	
Over pressure safety	psi	30	60	60	100	200	290	400	600	
Burst pressure	psi	75	150	150	250	500	500	1500	1500	
Pressure ranges	psi	500	1000	1500	2000	3000	5000	8000		
Over pressure safety	psi	1000	1740	2900	4000	6000	10000	17400		
Burst pressure	psi	2500	7975	11600	14500	17400	24650	34800		
{Absolute pressure: 0 ... 15 psi bis 0 ... 300 psi}										
Fatigue life		10 Mio. max. load cycles								
Materials										
■ Wetted parts										
» Pressure connection		316 L								
» Pressure sensor		316 L (up to 0 ... 10 bar rel 13-8 PH)								
■ Case										
» Lower body		316 L								
» Plastic head		Highly resistive, fibreglass-enforced plastic (PBT)								
» Keyboard		TPE-E								
» Display window		PC								
■ Internal transmission fluid		Synthetic Oil (only for pressure ranges < 0 ... 10 bar and ≤ 0 ... 25 bar abs)								
Power supply U+		DC 15 ... 35 V								
Signal output and maximum ohmic load R <sub>A</sub>	R <sub>A</sub> in Ohm	4 ... 20 mA, 3-wire				R <sub>A</sub> ≤ 0,5 k				
		0 ... 10 V, 3-wire				R <sub>A</sub> > 10 k				
		Adjustment zero point offset, max. 3 % of span								
Setting time (Analogue signal)	ms	3								
Current consumption	mA	max. 100								
Total current supply	mA	max. 600 (max. 500 with IO-Link) incl. switching current								
Switch points		Individually adjustable via external control keys								
■ Type		Transistor switching output PNP or NPN (SP1 = PNP with IO-Link)								
■ Number		1 or 2								
■ Function		normally open / normally closed; windows- and hysteresis function freely adjustable								
■ Contact rating	DC V	Supply voltage U <sub>+</sub> – 1 V								
■ Switching current	mA	SP1: 250 (100 mA with IO-Link) SP2: 250								
■ Response time	ms	≤ 10								
■ Accuracy	% of span	≤ 0.5 (setting accuracy)								
Insulation voltage		DC 500 V								
Display										
■ Design		14-Segment-LED, red 4-digits, height 9 mm electronic 180° rotatable								
■ Accuracy		≤ 1.0 ± 1 Digit								
■ Update	ms	100, 200, 500, 1000 (adjustable)								
Accuracy	% of span	≤ 1.0 *)								
		*) Including non-linearity, hysteresis, zero point and full scale error (corresponds to error of measurement per IEC 61298-2)								
Non-linearity	% of span	≤ ± 0.5				(BFSL) according to IEC 61298-2				
Long-term drift	% of span	≤ 0.2				according to IEC 61298-2				
Permissible temperature of										
■ Medium		-20 ... +85 °C				-4 ... +185 °F				
■ Ambience		-20 ... +80 °C				-4 ... +176 °F				
■ Storage		-20 ... +80 °C				-4 ... +176 °F				

# Specifications

# Model PSD-30

Rated temperature range		0 ... +80 °C	+32 ... +176 °F
Temperature error within rated temperature range		≤ 1.0 typ., ≤ 2.5 max.	
Temperature coefficients within rated temperature range			
■ Mean TC of zero	% of span	≤ 0.2 / 10 K	
■ Mean TC of span	% of span	≤ 0.2 / 10 K	
Reference conditions		Relative humidity: 45 ... 75 % according to IEC 61298-1	
Approval		cULus	
RoHS-conformity		Yes	
CE-conformity			
■ Pressure equipment directive		This instrument is a pressure accessory as defined by the directive 97/23/EC	
■ EMC directive		2004/108/EC, EN 61 326 Emission (Group 1, Class B) and Immunity (industrial locations)	
Shock resistance	g	50 according to IEC 60068-2-27	(mechanical shock)
Vibration resistance	g	10 according to IEC 60068-2-6	(vibration under resonance)
Wiring protection			
■ Overvoltage protection		DC 40 V	
■ Short-circuit proofness		S+/SP1/SP2 towards U-	
■ Reverse polarity protection		U+ towards U-	
Weight	kg	Approx. 0.2	

## Dimensions in mm

### Electrical connection

Circular connector \*)  
M 12x1

### Pressure connections

G 1/2  
EN 837

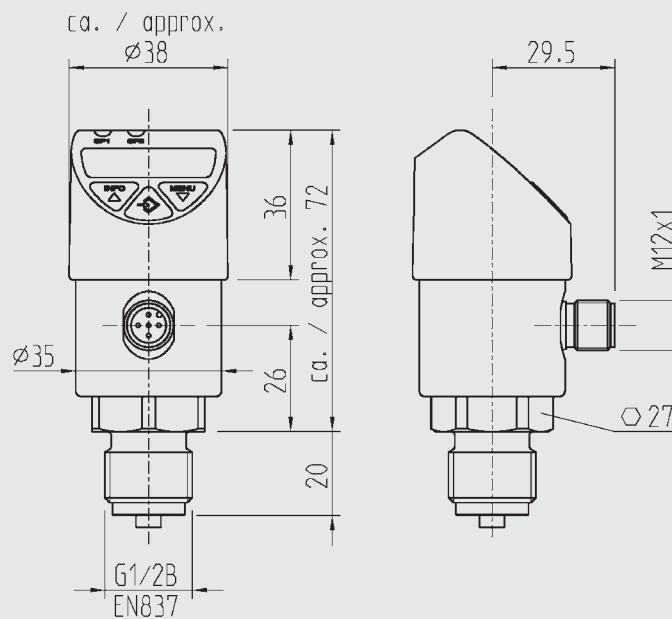

### Pressure connections

G 1/4  
EN 837

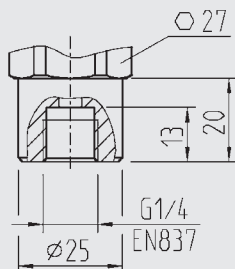

G 1/4  
DIN 3852-E

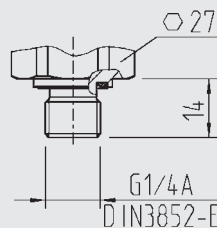

1/4 NPT  
per „Nominal size for US  
standard tapered  
pipe thread NPT“

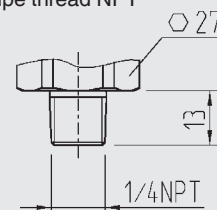

\*) Mating connectors are not included in delivery.

## Further Pressure connections

R 1/4 ISO7

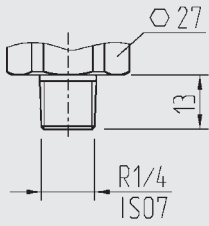

PT 1/4

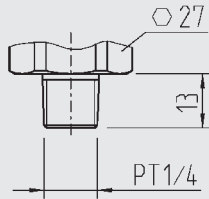

G 1/4 female  
(Ermeto compatible)

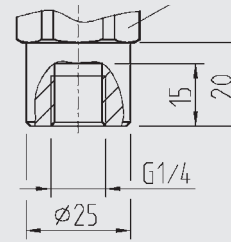

Others on request

For installation and safety instructions see the operating instructions for this product.

For tapped holes and welding sockets please see Technical Information IN 00.14 for download at [www.wika.de](http://www.wika.de)

## Electrical connections

Circular connector M12x1, 4-pin



2 switching outputs or  
1 switching output +  
1 analogue output

U+ = 1

U- = 3

SP1 = 4 /  
C = 4

SP2 = 2 /  
S+ = 2

Circular connector M12x1, 5-pin

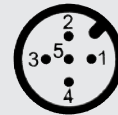

2 switching outputs + 1 analogue output

U+ = 1

U- = 3

SP1 = 4 /  
C = 4

SP2 = 2

S+ = 5

Ingress Protection per IEC 60 529

IP 65 and IP 67

IP 65 and IP 67

The ingress protection classes specified only apply while the pressure transmitter is connected with female connectors that provide the corresponding ingress protection.

### Legend:

- U+ Positive supply connection
- U- Negative supply connection
- SP1 Switching point 1
- SP2 Switching point 2
- S+ Analogue output
- C Communication with IO-Link

## Accessories

### Order No.

Mounting clamp

11467887

Specifications and dimensions given in this leaflet represent the state of engineering at the time of printing. Modifications may take place and materials specified may be replaced by others without prior notice.



**WIKAI Alexander Wiegand SE & Co. KG**  
 Alexander-Wiegand-Straße 30  
 63911 Klingenberg/Germany  
 Tel. (+49) 9372/132-0  
 Fax (+49) 9372/132-406  
 E-mail [info@wika.de](mailto:info@wika.de)  
[www.wika.de](http://www.wika.de)