



Pressure Transmitter

with CANOpen-Interface

TRONIC LINE

Standard Series • Typ D-10-9
Flush Diaphragm Series • Typ D-11-9

- Integrated CANopen Interface according to DS-301
- Device Profile DSP404
- Intelligent Sensor Technology with Calibration and Diagnosis Services
- Accuracy 0.25 %, (optionally 0.1 %) Temperature Drift included
- Measuring Ranges of 0 ... 250 mbar up to 0 ... 1,000 bar
- Hermetically welded High Performance Sensor Technology
- Excellent Long Term Stability and Repeatability
- Certified by User Organisation CiA

Description

The D-1X-9 is a precision transmitter with CAN interface. The integrated interface has been designed according to the CANopen specification DS-301 of the user organisation CiA. The device profile DSP-404 which is used here, has been specially designed by the CiA for the use in measuring and control instruments. This guarantees the compatibility with the systems of other manufacturers.

Due to the high accuracy of 0.25% of span (optionally 0.1%) without additional temperature drift within the range of 0 ... 50°C a temperature independent highly accurate measurement can be achieved.

Specially adapted protective EMC procedures together with an integrated galvanic separation of power supply and bus signal are a guarantee for a reliable data transmission even at transmission rates up to 1Mbaud.

All device parameters are accessible via the CANopen list of objects and can be configured with any CAN software available on the market. The modul addresses can also be set via DIP switches directly at the transmitter (address 1-31).

The main features of the D-1X-9 are access to the calibration data as well as a counter for over pressure and over temperature. As a consequence, the calibration history can be easily followed and a remote diagnosis via a supervisory control unit can be carried out.

The measuring ranges of 0 ... 0.25 bar up to 0 ... 1,000 bar at a nominal temperature range of -20 ... +80°C open a wide field of applications with high demands on precision, reliability and functionality.

The electrical connection is a locking plug M 12 x 1 (5-pins). This guarantees an ingress protection of up to IP 65 and an easy and reliable bus interface. Due to shock and vibration resistance values which comply with the industrial standards, it can be perfectly used for fieldbus applications in the sectors mechanical engineering, automation and test benches.



Supplementary data sheet:

- Pressure Transmitter with Profibus DP-Interface (see data sheet PE 81.30) **Model D-1X0-7**
- Pressure Transmitter for Precision Measurement with analog signal outputs (see data sheet PE 81.32) **Model P-1X**
- Pressure Transmitter for Precision Measurement with digital output RS 232 (see data sheet PE 81.33) **Model D-1X**
- Pressure Transmitter with CAN-Interface (see data sheet PE 81.34) **Model D-1X-8**

Specifications		Model D-10-9 and Model D-11-9																		
Pressure ranges	bar	0.25	0.4	0.6	1	1.6	2.5	4	6	10	16	25	40	60	100	160	250	400	600	1000
Over pressure safety	bar	2	2	4	5	10	10	17	35	35	80	50	80	120	200	320	500	800	1200	1500
Burst pressure	bar	2	2	4	5	10	10	17	35	35	80	250	400	800	800	1000	1200	1700	2400	3000
Pressure connection		G ½ B per DIN 16288 (G ¼ B, G ½ NPT) {other on request} M 18 x 1.5 female / G ¼ male G 1 B flush diaphragm with o-ring (pressure ranges: 0 ... 0.25 to 0 ... 1.6 bar) G ½ B flush diaphragm with o-ring (pressure ranges: 0 ... 2.5 to 0 ... 600 bar) {weld-on socket for flush diaphragm units with connection G ½ B, G 1 B}																		
Material		stainless steel 1.4571, 2.4711 (> 25 bar) (other materials see WIKA chemical seal) Only for flush diaphragm models: NBR {EPDM; Viton}																		
• Wetted parts		stainless steel 1.4571																		
• O-ring		stainless steel 1.4571 (from 25 bar: 1.4571 and 2.4711)																		
• case		Synthetic oil (only for pressure ranges up to 0 ... 16 bar or flush diaphragm units) {halocarbon oil for oxygen applications ¹⁾																		
• process connection / diaphragm internal transmission fluid		{vegetable oil for food industry}																		
Power supply U _b	DC V	10 ... 30																		
Power input	W	0.7																		
Signal output		CANopen protocol acc. to CiA DS-301, Device profile DSP 404																		
Communication services		LSS (CiA DSP 305, version 1.0) Services, configuration of device address and baud rate Sync/Async Node/Lifeguarding																		
Diagnosis data		Emergency message, if • pressure is 5% below minimum of measuring range • or pressure is 5% beyond maximum of measuring range • or temperature at sensor is higher than 80 °C																		
Termination		internal termination can be activated via integrated DIP-switch																		
Measuring rate	Hz	≤ 100																		
Warm-up time	min	< 10																		
Accuracy * (including linearity, hysteresis and repeatability)	% of span	≤ 0.25 {0.10} in the range 0 °C ... +50 °C																		
Hysteresis	% of span	≤ 0.10 {0.04}																		
Repeatability	% of span	≤ 0.05 {0.03}																		
1-year stability	% of span	≤ 0.10 (under reference conditions)																		
Permissible temperature of																				
• medium	°C	-20 ... +80													-4 ... +176 °F					
• ambient	°C	-20 ... +80													-4 ... +176 °F					
• storage	°C	-40 ... +85													-40 ... +185 °F					
Compensated temp. range																				
Temperature coefficients in compensated temp range:	°C	-20 ... +80													-4 ... +176 °F					
• mean TC of zero	% of span/10K	≤ 0.20 {0.10}																		
• mean TC of range	% of span/10K	≤ 0.20 {0.10}																		
		(the temperature related deviations in the range 0 ... +50 °C (32 ... 122 °F) are already included in the accuracy)																		
α -conformity		Interference emission see EN 50 081-1 and EN 50 081-2, Interference immunity see EN 50 082-2; declaration of conformity on request																		
Shock resistance	g	< 100 according to IEC 770 (mechanical shock)																		
Vibration resistance	g	< 5 according to IEC 770 (vibration under resonance)																		
Electrical connection		5-pin plug M 12 x 1, IP 65 {other electrical connection and IP 67 on request}																		
Wiring protection		protected against polarity crossing and short circuiting, galvanic separation																		
Degree of protection per EN 60 529 / IEC 529																				
Weight	kg	approx. 0.4																		
Dimensions		see drawings																		
Items in curved brackets { } are optional extras for additional price.																				
* calibrated in vertical mounting position with the pressure connection facing down.																				
¹⁾ The oxygen version must not be operated under medium temperatures higher than 60 °C (140 °F)																				
The oxygen version cannot be manufactured for negative pressure ranges and for absolute pressure ranges < 1 bar abs.																				
Detailed information about the list of objects can be found in the respective manual.																				

Dimensions in mm

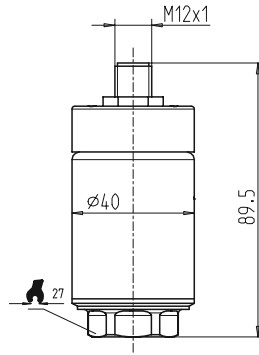

Pressure connection G 1/2 B

M 18 x 1,5

G 1/4 B

1/2 NPT

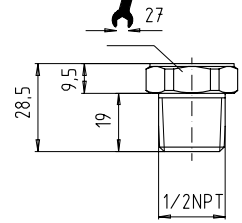
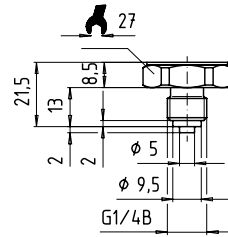
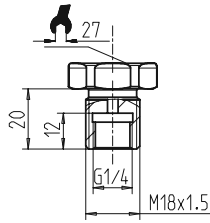

Sockets

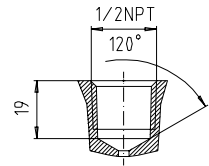
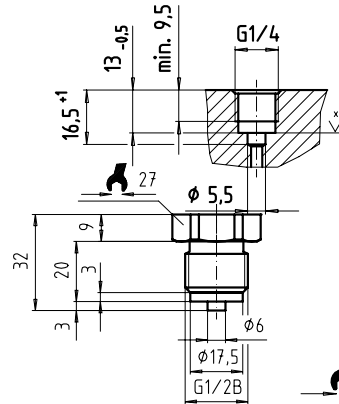
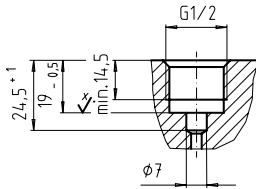

Pressure connections for flush diaphragm model

G 1/2 B

G 1 B

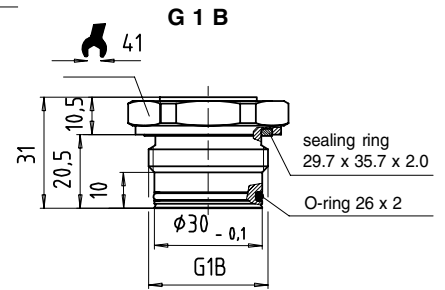
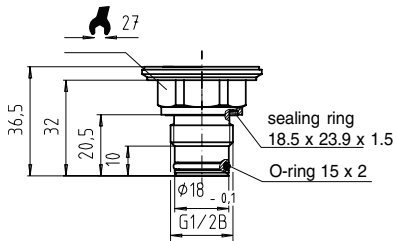

Flush diaphragm sockets

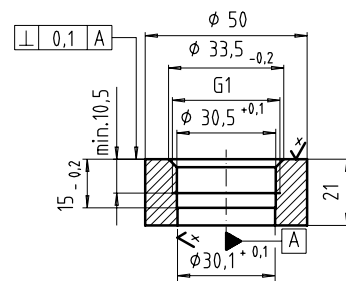
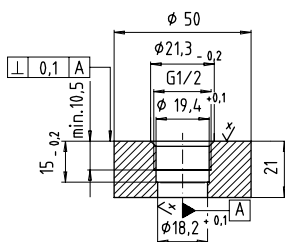

Pin configuration

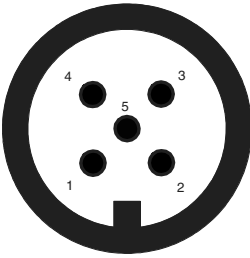

male

Pin configuration

- 1 -
- 2 - U_B+
- 3 - OV
- 4 - Bus-signal CAN-High
- 5 - Bus-Signal CAN-Low

9057331 GB 30 CM 03.01

Specifications and dimensions given in this document represent the state of engineering at the time of printing. Modifications may take place and materials specified may be replaced by others without prior notice.



WIKAI Alexander Wiegand GmbH & Co. KG
Alexander-Wiegand-Straße · 63911 Klingenberg
☎ ++49 . 93 72 . 132 - 0 · ☎ - 406 / 414
<http://www.wika.de> · E-mail: support-tronic@wika.de